



PALLET TRUCK SCALES

PROFESSIONAL MEASURING





KERN Pictograms

 **Internal adjusting**
Quick setting up of the balance's accuracy with internal adjusting weight (motordriven)

 **Adjusting program CAL**
For quick setting up of the balance's accuracy. External adjusting weight required

 **EasyTouch**
Suitable for the connection, data transmission and control through PC or tablet

 **Memory**
Balance memory capacity, e.g. for article data, weighing data, tare weights, PLU etc.

 **Alibi memory**
Secure, electronic archiving of weighing results, complying with the 2014/31/EU standard.

 **KERN Universal Port (KUP)**
allows the connection of external KUP interface adapters, e.g. RS-232, RS-485, SB, Bluetooth, WIFI, Analogue, Ethernet etc. for the exchange of data and control commands, without installation effort

 **RS-232 Data interface**
To connect the balance to a printer, PC or network

 **RS-485 Data interface**
To connect the balance to a printer, PC or other peripherals. Suitable for data transfer over large distances. Network in bus topology is possible

 **USB Data interface**
To connect the balance to a printer, PC or other peripherals

 **Bluetooth* Data interface**
To transfer data from the balance to a printer, PC or other peripherals

 **WIFI Data interface**
To transfer data from the balance to a printer, PC or other peripherals

 **Control outputs**
(optocoupler, digital I/O)
To connect relays, signal lamps, valves, etc.

 **Analogue interface**
to connect a suitable peripheral device for analogue processing of the measurements

 **Interface for second balance**
For direct connection of a second balance

 **Network interface**
For connecting the scale to an Ethernet network

 **KERN Communication Protocol (KCP)**
It is a standardized interface command set for KERN balances and other instruments, which allows retrieving and controlling all relevant parameters and functions of the device. KERN devices featuring KCP are thus easily integrated with computers, industrial controllers and other digital systems

 **GLP/ISO log intern**
The balance displays weight, date and time, independent of a printer connection

 **GLP/ISO log Printer**
With weight, date and time. Only with KERN printers.

 **Piece counting**
Reference quantities selectable. Display can be switched from piece to weight

 **Recipe level A**
The weights of the recipe ingredients can be added together and the total weight of the recipe can be printed out

 **Recipe level B**
Internal memory for complete recipes with name and target value of the recipe ingredients. User guidance through display

 **Totalising level A**
The weights of similar items can be added together and the total can be printed out

 **Percentage determination**
Determining the deviation in % from the target value (100 %)

 **Weighing units**
Can be switched to e.g. nonmetric units. See balance model. Please refer to KERN's website for more details

 **Weighing with tolerance range (Checkweighing)**
Upper and lower limiting can be programmed individually, e.g. for sorting and dosing. The process is supported by an audible or visual signal, see the relevant model

 **Hold function**
(Animal weighing program)
When the weighing conditions are unstable, a stable weight is calculated as an average value

 **Protection against dust and water splashes IPxx**
The type of protection is shown in the pictogram

 **Suspended weighing**
Load support with hook on the underside of the balance

 **Battery operation**
Ready for battery operation. The battery type is specified for each device

 **Rechargeable battery pack**
Rechargeable set

 **Universal plug-in power supply**
with universal input and optional input socket adapters for
A) EU, CH, GB
B) EU, CH, GB, US
C) EU, CH, GB, US, AUS

 **Plug-in power supply**
230V/50Hz in standard version for EU, CH. On request GB, USA or AUS version available

 **Integrated power supply unit**
Integrated in balance. 230V/50Hz standard EU. More standards e.g. GB, USA or AUS on request

 **Weighing principle Strain gauges**
Electrical resistor on an elastic deforming body

 **Weighing principle Tuning fork**
A resonating body is electromagnetically excited, causing it to oscillate

 **Weighing principle Electromagnetic force compensation**
Coil inside a permanent magnet. For the most accurate weighings

 **Weighing principle Single cell technology**
Advanced version of the force compensation principle with the highest level of precision

 **Conformity Assessment**
The time required for conformity assessment is specified in the pictogram

 **DAkkS calibration possible (DKD)**
The time required for DAkkS calibration is shown in days in the pictogram

 **Factory calibration (ISO)**
The time required for Factory calibration is shown in days in the pictogram

 **Package shipment**
The time required for internal shipping preparations is shown in days in the pictogram

 **Pallet shipment**
The time required for internal shipping preparations is shown in days in the pictogram

*The *Bluetooth*® word mark and logos are registered trademarks owned by Bluetooth SIG, Inc. and any use of such marks by KERN & SOHN GmbH is under license. Other trademarks and trade names are those of their respective owners.

KERN Models A-Z

440	30
572	34
A	
ABP	50-51
ABP-A	52
ABT-NM	48
ACS/ACJ	46-47
ADB/ADJ	43
ALS-A/ALJ-A	44-45
B	
BFB	124-125
BFN	126
BIC	121
BID	122-123
C	
CB Q1 · CB Q2 · CB P1	160
CCA	94-95
CCS	96-97
CDS	93
CE Hx	138
CFS	90
CH	169
CIB	87
CJ P · CJ X	163
CKE	91
CM	10
CO Y1 · CO Y2 · CO Y5	162
CP P4 · CP Y4 · CP P1 · CP Y1 · CP P3	157
CP P2 · CP P8 · CP P7 · CP P9	158
CR Q1 · CR P1 · CR Y1	159
CT Q1 · CT P1 · CT P2	161
CPB	89
CXB/CXB-NM	88
D	
DAB	54
DBS	55
DE	106-107
DLB	56
DS	115
E	
ECB-N/ECE-N	59
EFS	13
EG-N/EW-N	37
EHA	17
EMB	14
EMB-V	15
EMS	16
EOB	104
EOC	108-109
EOE	103
EOS	105
EWJ	31

F	
FCB	61
FCE-N	60
FCF	69
FES/FEJ	41
FFN	74
FGE	68
FKB	62-63
FOB-LM	70
FOB-S · FOB-NS	71
FOB · FOB-NL	72
FXN · FXN-M	75
G	
GAB-N	64
H	
HCB	171
HCD	173
HCN	172
HDB-N · HDB-XL	170
HFA	174
HFC	175
HFD	176-177
HFM	180
I	
IFB	114
IFC NEW	112-113
IFS	92
IOC	110-111
IXC NEW	116-117
K	
KBP-V20 IP65 NEW	152
KDP	139
KFA-V20	154
KFB-TM	148
KFC-TM	150
KFD-V20	153
KFD-V40 IP68	155
KFN-TM	149
KFP-V20 IP65	152
KFP-V20 IP67	153
KFP-V30	154
KFP-V40 IP68 NEW	155
KFS-TM	148
KFU-V20	154
KFU-V30	154
KGP	136
KIB-TM	149
KIP-V20M	153
KXC-TM	151
KXP-V20 IP65	152

N	
NFB	133
NIB	132
NFN	134
P	
PBJ/PBS	39
PCB	28-29
PCD	26
PCJ NEW	32-33
PEJ/PES	40
PFB	27
PLJ/PLS	35
PNS/PNJ	36
PWS	38
R	
RIB	80
RPB	81
S	
SCD-4.0	186
SCD-4.0-PRO	187
SFB/SFB-H	78
SFE	118
SXC NEW	76-77
T	
TGC	11
TGD	11
U	
UFA	127
UFB	130
UFN	131
UIB	128
UID	129
V	
VHB	165
W	
WTB	73
Y	
YKV	137
YRO-01/-02/-03	192



KERN Quick-Finder

How I quickly find the product I am looking for

Ahead of each product group allows you to base the search for a certain target group on weighing data you need such as readout, weighing capacity and main features for each model.

And it's as simple as that – find the product you want in 2 steps:

1. Go to the product group index on page 3
2. Pick the appropriate product group and find the product you want using the Quick-Finder

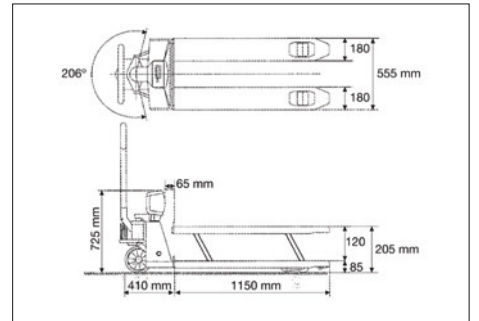

Pallet truck scale with complete protection against dust and water splashes IP65/67 and a memory for a container weight

Features

- PRE-TARE function for manual subtraction of a known container weight, useful for checking fill-levels
- **1** Display device: Plastic, protected against dust and water splashes IP65
- **2** Load fork: Protection against dust and water splashes IP67, temporary use in wet areas possible
- Pivot range 206°
- Castors: Solid rubber on aluminium rims
- **3** Load rollers: Tandem tyres to overcome thresholds and obstacles more easily
- Summation of weight values
- Ready for use: Batteries included, 4×1.5 V AA, operating time up to 80 h

Technical data

- Large LCD display, digit height 28 mm
- Permissible ambient temperature -10 °C/40 °C

Accessories

- **4** Castors made of polyurethane on aluminium rims. Ideal for light-coloured flooring as they leave less visible abrasive marks. Suitable for the current models of the pallet truck scale range KERN VHB (when retrofitting, please give the serial number of the pallet truck scale available when ordering), scope of delivery: 1 item, KERN VHB-A02, € 140,-

STANDARD

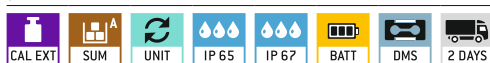

OPTION



1 **2**

Model	Weighing capacity	Readability	Linearity	Net weight	Price excl. of VAT ex works €	Options DAKKS Calibr. Cert. DAKKS KERN	DAKKS	€
KERN VHB 2T1	[Max] kg 2000	[d] kg 1	kg ± 2	approx. kg 110	1930,-	963-131	275,-	

! Shipment via freight forwarder. Please ask for dimensions, gross weight, shipping costs

KERN & SOHN GmbH

Balances, Test Weights, Microscopes,
DAkkS Calibration Laboratory
Ziegelei 1
72336 Balingen
Germany
Tel. +49 7433 9933-0
info@kern-sohn.com
www.kern-sohn.com

**The oldest Precision Balance
Factory in Germany**



**Discover the multifaceted World of Balances, Microscopes and Measuring Technology
from KERN online: www.kern-sohn.com**



- Full KERN & SAUTER Product Range
- Convenient 24/7 Ordering
- Selection of more than 5,000 Items across Weighing and Measuring Technology, Optical Instruments as well as Accessories and Services
- Extensive Information and useful Download Options
- Technical Product Data Sheets
- Operating Instructions
- Descriptive Image and Video Material
- Useful KERN Services
- Technical Glossary
- KERN Dealer Portal
- Practical Filter and Search Functions



Follow us on our social media channels too



Printed in Germany by KERN & SOHN GmbH
z-cb-en-kr-20241

